

Contents of this manual:

- Introduction
- The parts of the kit
- Dismantle the palmtop
- Prepare the screen
- Install the backlight
- Prepare the motherboard
- The inverter module
- Reassemble the palmtop and connect the backlight
- Load the backlight driver

Introduction

This document describes how to install a backlight for the Hewlett Packard 100LX, 200LX and 1000CX palmtops based on the Backlight Kit, sold by backlight4you (<http://www.backlight4you.com>).

This backlight solution is based on EL (Electroluminescence) foil, which provides an evenly distributed flat light source. The EL foil is driven by a high voltage (approx. 150-200 V AC), which is produced by a so-called inverter module. This inverter needs 5V DC to work, this voltage is available in the palmtop. In addition the inverter optionally takes a 5V TTL signal for activating the backlight. This TTL signal is available on an unused I/O pin of the CPU. This makes it possible to switch the backlight on and off by software.

Disclaimer:

Please let me clearly say, that a do-it-yourself installation of the backlight-kit may be one of the fastest ways to destroy your beloved HP-palmtop permanently! This backlight-kit is intended for technical skilled persons, only! Please understand, that we ask you to read this installation manual carefully BEFORE buying or installing the backlight-kit. If you come to the conclusion that you better not install the backlight yourself, we appreciate your self-consciousness and decision. We are willing to refund the price of the backlight-kit, fully (except shipping-costs). In reading this installation guide you agree to free us from any responsibility for any kind of primary or secondary damage, which might occur as a consequence of this backlight-upgrade. We only guarantee that this backlight-kit was developed and tested according to our best knowledge and intentions. No further guaranties are given. So, there is no guarantee that the backlight will work after you installed it, and there is a relatively high risk to damage the screen or other parts of the palmtop permanently.

Please notice that you might loose guarantee/warranty for other upgrades and installations when opening your palmtop! Please make use of one of the upgrade-services for the backlight-installation if you decide not to install it yourself.

After the installation of the backlight, the contrast of the screen at daylight will not be as crisp as before, because the reflecting foil on the back of the screen has to be removed, and the surface of the EL foil will be the new reflection layer. However, in bright light this is not noticeable, and when the surrounding light is insufficient, you can switch on the backlight. Therefore, you will be able to read the screen in every light condition.

Another issue is the impact on the superior battery life of the 200LX, which is of course reduced by the backlight. However, the components of this kit are designed for power-economy, and measurements have shown that battery life would only be reduced by 50% if the backlight is switched on all the time. (actual impact may vary depending on hardware and installed upgrades such as doublespeed and memory). That is very little compared to other possible backlight solutions. And

considering that you will probably not have the backlight switched on all the time, the actual impact on battery life should be much less.

The parts of the kit

The backlight4you.com backlight kit contains the following parts:

- an EL panel
- special adhesive copper foil for contacting the EL foil
- an inverter module with attached battery clip
- a piece of transparent foil
- a Diskette / CD-ROM with installation instructions and software driver

For installation, you will need:

- A Torx-6 screwdriver for the palmtop screws
- A plastic card, e.g. a credit card or calling card (as a tool for opening the palmtop)
- Good soldering equipment with a fine soldering tip
- A sharp razor blade or a scalpell
- A small normal screwdriver
- Approx. 1m (3 feet) of thin insulated wire (0.1mm - 0.3mm diameter, as used for coils)
- 30cm (1 ft) insulated wire 1mm diameter
- thin heat shrink tubing (1mm, 3mm diameter, only a few cm im length)
- Silicone oil to seal the EL foil against humidity
- Ethyl alcohol for cleaning the foils (don't use isopropyl alcohol, because that can damage the foils! You can use denatured Ethyl alcohol, but only if it doesn't leave a visible residue on a glossy surface.)
- maybe you will need petroleum (depends on the kind of screen, it is for rubbing off some glue, see below)
- some tissue paper
- Adhesive tape (Scotch tape for example) for insulating purposes

Dismantle the palmtop

1. Make a backup of all your data and ensure that you know how to restore it after the upgrade!
2. Remove all removable parts (PCMCIA card, battery / IR port covers, all batteries).
3. Remove the four rubber feet from the bottom using a small screwdriver.



4. Unscrew the four Torx-6 screws under the rubber feet.

- Remove the two hinge caps.



- Carefully separate the two halves of the palmtop body shell. Begin at the short side where the PCMCIA slot is, put the palmtop with the backup battery side onto the table, then use the plastic card: insert it about 0.5cm into the gap on the long side and move it carefully down towards the backup battery slot, levering a bit.

Be careful not to damage the keyboard contacts, which are placed approximately under Menu, Shift, Zero, Dot keys. There the shell halves are pressed together with two plastic pins. Don't break these pins! Lever carefully! Sometimes it is better to stop on this side and continue with the back (where the battery compartment is), if the front is too hard to open at the beginning.



If you are done with the front side, the halves should be separated except one position in the battery compartment where the plus pole of the battery is placed. Pull the case shortly and firmly apart at that position.

- Sometimes the battery contacts still are fixed in their clips on the mainboard. To detach them, simply use the small screwdriver to unclip their contacts from outside, you should then be able to detach the bottom shell part and lay it aside.



8. Check to see if the battery contacts in the bottom shell came out of their mountings and if so, press them back into position.

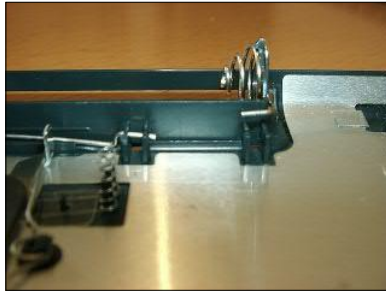

9. You now see the motherboard lying in the keyboard shell. Detach the screen cable from its motherboard connector using your fingernail to slide the top restraining clasp toward the cable. Once the screen cable is disconnected, you can simply take out the motherboard.

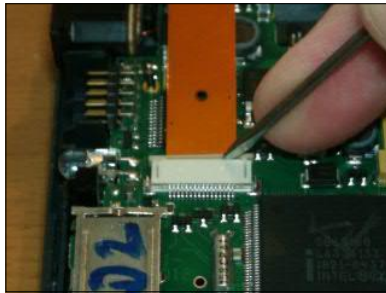

10. Use the small screwdriver to remove the two white discs, which fix the hinge tube. Rotate them by 45 degrees, then you can simply remove them.



11. Now open the palmtop to an angle of about 90 degrees between screen and keyboard. Press the hinge tube together and pull it, together with the screen, away from the keyboard case. Begin on the left side, on the right side it may be harder, because the right hinge is also connected to the keyboard case by a little metal pin, which sometimes needs a bit more force to be pulled out of his hole. Carefully pull the display cable and the ground cable out of the keyboard case and lay the keyboard case aside.





- Remove the display cover. Use a small knife or screw driver to peel the cover off in one edge, then pull it off entirely. This needs a bit of force, but can easily be reattached afterwards. Take care not to scratch the screen!



- Unscrew the four Torx-6 screws of the screen



- Use the plastic card to lever the two screen shell halves apart, begin in the lower left corner, be careful with the closing latch on the top, it has very sensitive legs. **Never** take apart the right hinge, it contains very strong mechanics, which cannot be reassembled in most cases. If all sides of the screen shell are separated (except of the lower right corner where the hinge is), you can take out the screen. Don't break any plastic parts! Also, when extracting the screen, be careful not to scratch the screen on the case pegs that hold the two shell halves together.





- 15. Never disassemble or damage the right hinge:



Prepare the screen

The screen consists of several layers. On the back there is the printed circuit board. Most of them have ICs on the back, some don't. Those which don't, have the ICs on the other side (the side which faces the LCD). On the front there is the LCD, which is connected on the long sides for the pixel columns with rubber strips which contain conductive parts and on the right short side with a ribbon cable, which cannot be removed without damaging the screen forever. All this is pressed together by a metal frame.

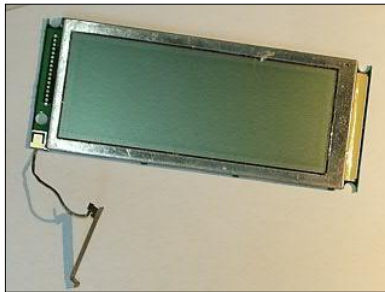

Here is a schematic drawing of the LCD (side view profile, without the circuit board and the electrical connections, just the optically relevant components are shown):

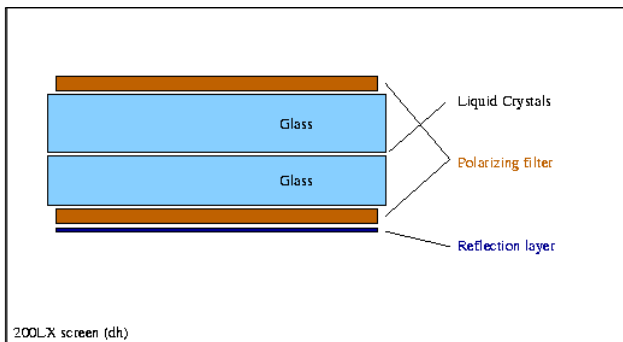

The reflection layer will have to be removed and replaced by the transparent foil. Behind the transparent foil the EL foil will be placed. In some cases (described below) the transparent foil can be

left away and the EL foil can be placed directly under the polarizing layer without the need of a separating transparent foil.

1. Remove the metal frame. On the back there are metal latches, which are bent so that they clench the circuit board. Lie the screen on a table face down. Next, bend all these latches to the left or right (depending on the latch), so they are straight and no longer pressing against the screen.

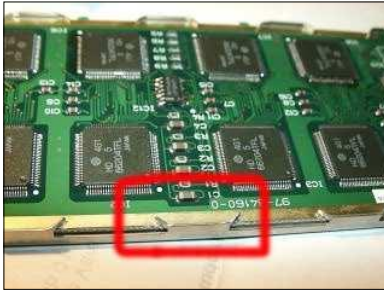

Then the metal frame can be removed from the screen. But do not separate the LCD from the circuit board yet.



2. Apply some markings with a sharp pen on the white rubber and on the side of the circuit board, so you can later adjust both into their exact relative horizontal position they are now in. Apply more than one such markings on one side, so you may later see a few of them even if the metal frame is attached again.

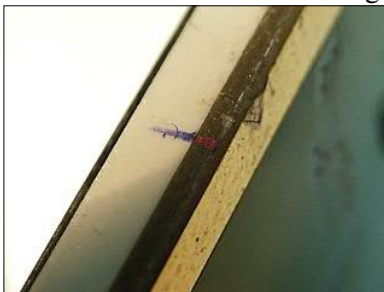

3. Open the sandwich: separate the LCD from the circuit board, take care that the white rubber strips remain on the LCD and take care not to damage the yellow ribbon cable between LCD and circuit board. If the white rubber bands don't stick on the LCD, you may have problems when reassembling the screen. See below.



Take much care of the yellow ribbon cable! If you apply too much force to it, that can lead to missing horizontal lines after the upgrade process. This is not repairable!
For the following steps, please put the LCD part of the screen onto a thin book (about 10mm) or something similar, so that the circuit board "hangs" on the yellow ribbon

cable and thus force applied to the LCD does not affect the ribbon cable:



All the following pictures don't show that book!

4. Clean the piece of transparent foil from the kit with ethyl alcohol to remove all dust, stripes and fingerprints. **Important:** Once clean, make sure to keep the transparent foil within reach as you will need to perform the next two steps one right after the other.
5. Now the reflective foil on the back of the LCD has to be removed. Do this in a very clean environment: The glue remaining on the LCD will quickly attract dust or dirt, which cannot be removed anymore without leaving tracks in the glue. Begin to lift the reflective layer in one corner using a razor blade or scalpel, then pull it off with force, but do not break the screen! This process may need quite some force, so be careful! Also make sure that you really only lift up the very thin reflective foil, and not the polarizing foil between the reflective foil and the glass! Also do not touch the glue which remains on the polarizing layer. It must be kept as clean as possible!

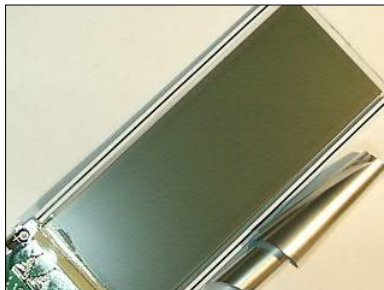
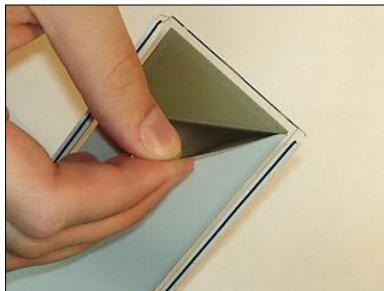

Don't worry if some pixel columns of the screen turn black during any action on the screen, this is due to static electricity and not dangerous in small amounts. They will return to normal again after some time or when you connect the circuit board:



Attention: There seem to be two kinds of screens.

- One kind where all the glue the reflective layer is mounted with remains on the polarizing layer (about 90% if the screens seem to be of that kind). If the reflecting side of the reflection layer feels perfectly sleek (not sticky) and if the glue surface on the polarizing layer looks perfectly consistent (don't touch it!!), you have such a screen. If so, **quickly proceed with the next step** (applying the transparent foil)!
 - If some glue remains on the reflection layer, and as a result the glue surface on the polarizing layer looks ugly (tracks, stripes, holes), you have one of the other kind of screens. In that case, you will have to remove all the glue from the polarizing layer using petroleum and a piece of tissue paper. It needs some minutes of scrubbing. Scrub until the surface looks perfectly clean and consistent! And make sure that you still keep the white rubber bands in place!
Then clean everything (also all the contacts) with ethyl alcohol. Now you should have a clean polarizing layer surface, which doesn't feel sticky anymore.
Omit the next step (you don't need to apply the transparent foil in that case!).
6. **This is the most trickiest part of the backlight installation process:** Attach the piece of transparent foil where you just removed the reflective foil. This is to cover the glue on the polarizing layer and to establish a small distance between the polarizing foil and the EL foil so that both cannot join optically.
Take care not to produce any air bubbles, so begin to attach it on one short side, then press it millimeter by millimeter using your thumbs and hold the other side of the foil up using perfectly clean fingers.

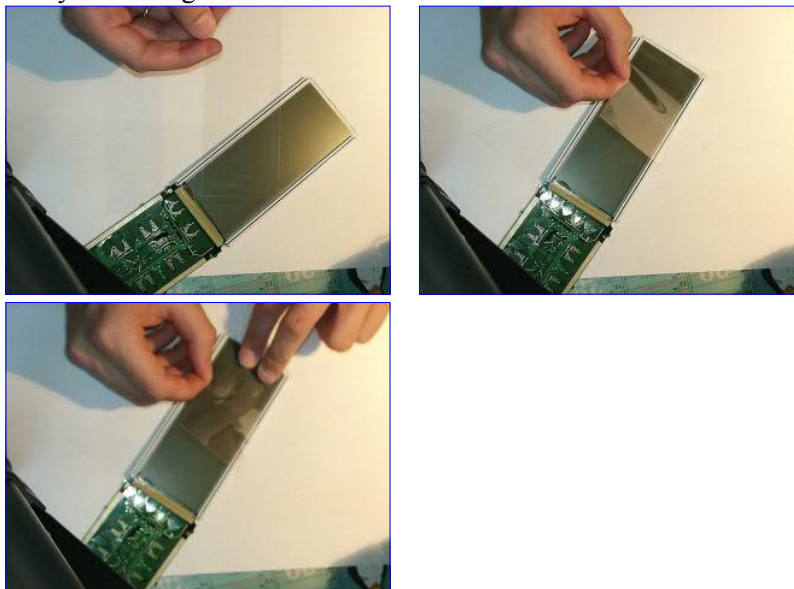

If you want to take a break, do it now. It is safe to let the screen lie around now that the glue is covered.

Install the backlight

1. Prepare the EL foil:

1. Cut off the black border on the contacts side, so that the outer contact is directly at the edge of the foil.
2. In the kit you find a piece of adhesive copper foil. The glue on the bottom of that foil is electrically conductive, i.e. you can directly attach it to the contacts of the EL foil. Cut it into two pieces, which are as wide as the metal contacts of the EL foil and about 4cm long.



3. Clean the metal contacts of the EL foil carefully with an eraser or another kind of rubber, remove the protection layer of one of the copper foils and attach the copper foil firmly to the EL contact as the following pictures show:

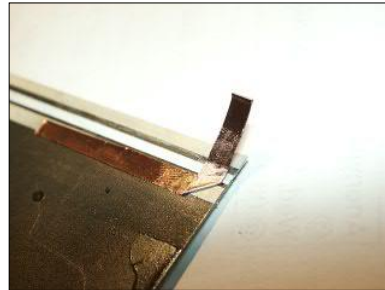
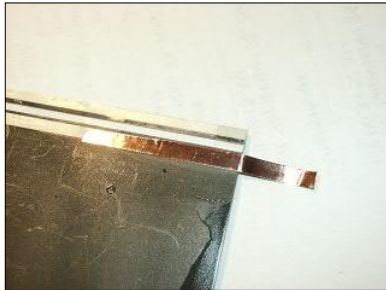

4. Insulate the other EL contact, where the copper foil crosses it, using adhesive tape!
5. Turn up the last 5mm of the tail and glue it "to itself", so that it is now two-layered and non-adhesive.
6. Now do the same with the other EL contact using the other piece of copper foil, as the following picture shows:

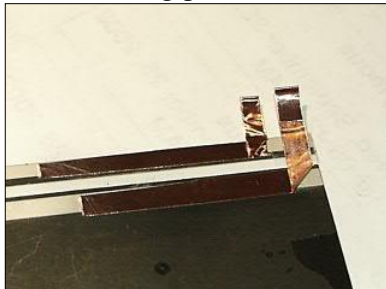

7. Apply a drop of soldering tin to both contact ends, and use pliers to hold the copper foil up to deduce heat from the foil. The soldering heat would destroy the contact glue.

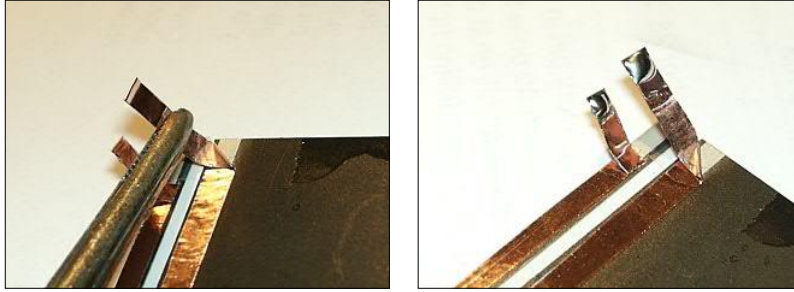

8. Now solder well insulated wires to the contacts, they may be thin (0.3mm), but the insulation must stand voltages up to 200V.
9. Everywhere a short-circuit could be created, insulate everything well using adhesive tape. For example where the copper foil of one contact crosses the silver track of the other contact. Rather insulate too much than too little!
10. Cover the entire back of the EL foil with adhesive tape to insulate it and to fasten the firm hold of the copper contact foil.

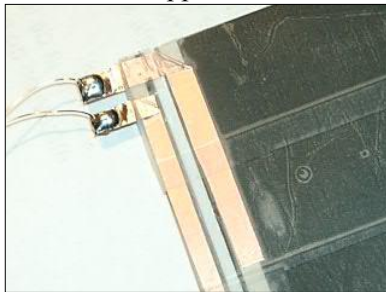

11. Turn the upper contact back behind the EL foil, ensure that everything is well insulated. Lead its wire the same way as the other wire and fix and insulate everything again using adhesive tape. I have used transparent Scotch tape, but it is also possible (and may in fact be better) to use some thicker and more stable tape.



12. Clean the EL foil surface with ethyl alcohol to remove dust and fingerprints.
13. Use a little (!) amount of Silicone oil to seal the edges of the EL foil against humidity, be careful that the oil does not get onto the surface of the EL foil! If you don't seal the foil, it will wear out much faster. Don't use any finish or paint, because it may contain solvents which may injure the EL foil.
14. Test the EL foil by connecting it to the inverter and connecting the inverter to a 5V source (not to a 9V block battery, as the battery clip may imply!!) The foil should glow greenish. Don't touch any contacts, 200V AC is not pleasant, although not normally dangerous, since the current is very small.
2. Insulate the large ground contact on the front side of the circuit board in the lower left corner using a small piece (10mm * 11mm) of adhesive tape.

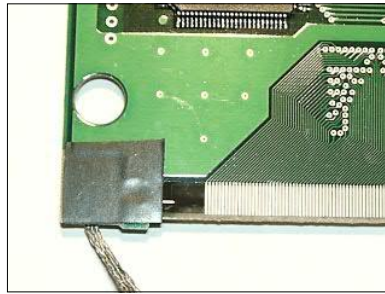
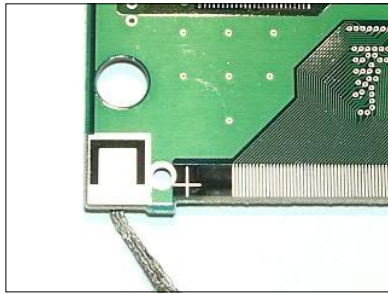

3. Clean the transparent foil surface on the back of the LCD with the ethyl alcohol to remove dust and fingerprints.
4. Put two layers of tissue (47mm * 110mm) onto the circuit board right besides the IC

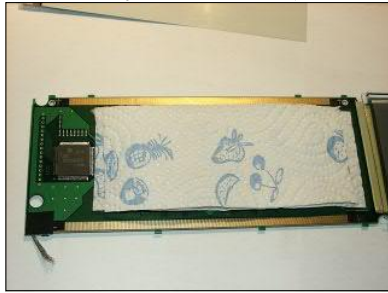

Ignore the shortened ground cable on this picture. This is a demonstration unit, your ground cable should be longer and end in a metal connector.

5. Place the EL foil behind the LCD between the white rubber bands. The EL foil contacts must be placed so that they will be in the lower left corner of the LCD after reassembling.
6. Flap the LCD back onto the circuit board with the tissue and take care that the tissue fits between the white rubber bands of the LCD. The EL foil should be pressed gently towards the LCD by the tissue. If the rubber bands don't stick to the LCD anymore, try to place them as they were placed before, don't bend them too much, don't stretch them and make sure that they cover the entire contact rows on the circuit board.
7. Fixate the EL foil on the left side with a small piece of adhesive tape to the LCD so that it cannot move sideways anymore.

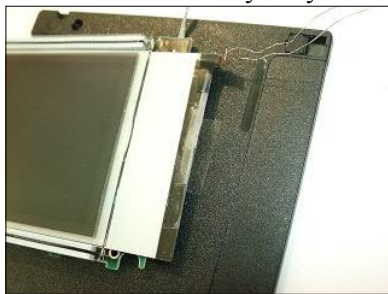

Side view:

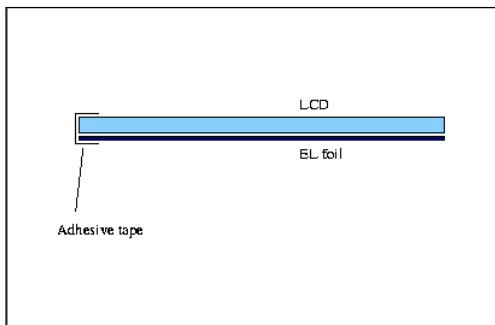

8. The EL foil should be entirely *under* the glass on the left side, because otherwise the metal frame will squeeze the EL foil later which may lead to short-circuits and other nasty things.
9. Cut the left edge of the metal frame so that there is enough space for the contacts of the EL foil. Make Sure that the EL contacts are also insulated against the metal frame! Reattach the metal frame (best is to sand the metal frame edges smooth and cover them with thick gray tape, this is not shown on the pictures below). Make sure the markings you have applied match again, so that the horizontal adjustment of the LCD is 100% correct!

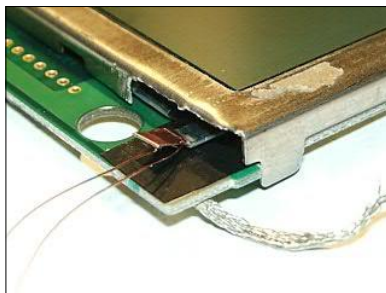
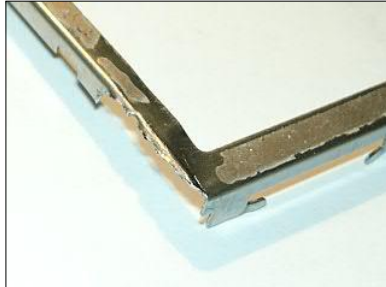

10. Bend the little latches back over the circuit board again.

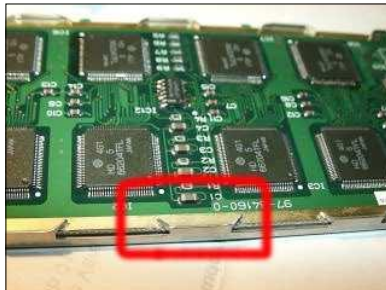

11. Test if the screen displays everything again: Connect the display ribbon cable to the motherboard, put the screen into its shell, connect the motherboard to a regulated 12V DC adapter (use the correct orientation: minus inside, plus outside!) and press the screen contacts firmly to the screen ribbon cable inside the screen shell. If the picture looks strange (missing columns, shifted columns which are not caused by a double speed upgrade, or whatever) you have probably reassembled the screen in an incorrect manner. Especially if the white rubber strips didn't stick on the LCD, it is very likely that you will see many missing columns. Repeat the disassembling / reassembling cycle rearranging the rubber band positions, until everything looks good. Then go on.
If you see missing pixel **rows** (horizontal) which were not missing before the upgrading, you have most probably applied too much force to the yellow ribbon cable on the right. This is bad, since it can only be fixed with a high risk to damage the screen even more. Please read my Repair page (<http://www.daniel-hertrich.de/repair>) to learn how to fix that problem.

Prepare the motherboard and inverter for software-control

Do this only if you want to switch the backlight on and off using a hotkey. If you want to use an SMD switch with the backlight kit, you don't have to do any modification to the motherboard! In

that case just put a switch into the +5V line of the inverter module and place that switch somewhere where it is convenient.

1. *In this step we will lift the CPU pin which controls the backlight. It is also possible to solder a thin wire to the pin without lifting it from the circuit board, however there is danger to connect it accidentally to one of the surrounding pins, which is hard to undo. So choose the way which you are more comfortable with. If you think you would prefer to leave the pin on the board, omit this step and continue with the next step.*

When soldering directly on the CPU, always be careful about statical electricity!

Find Pin 48 of the CPU. It is the 48th pin counterclockwise from the marking. It is the 5th pin from the right on the pin row which shows to the front side.

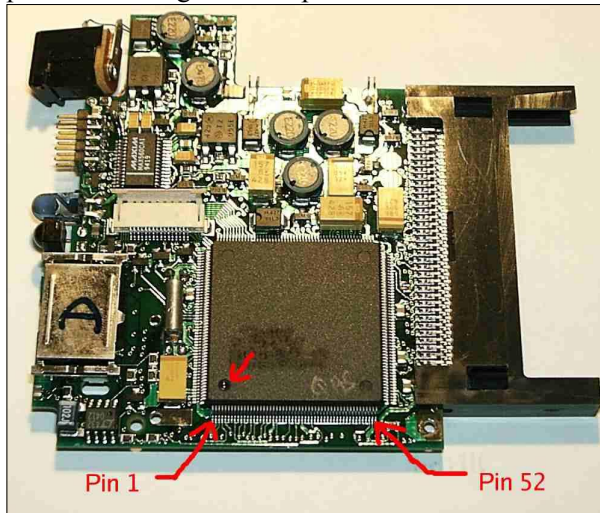

Remove the pin from the motherboard, so that it is free to attach a wire to it. Use a piece of very thin wire (0.1mm diameter, a few cm long) or an injection needle, bent to a small hook at the end, slip the hooked wire / needle around the pin, heat the pin base for a few seconds, then pull the wire or needle. This should lift the pin a bit and detach it from the motherboard. Of course you can also use a professional pin gripper, if you have one. Take great care not to break the pin, bend it up only once, then once adjust it so that it doesn't touch any other pin. It breaks very easily! If the pin is broken, the palmtop maybe continues to work (there seem to be palmtops which refuse to work when the pin is broken!), but you don't have the chance to software-control the backlight anymore.

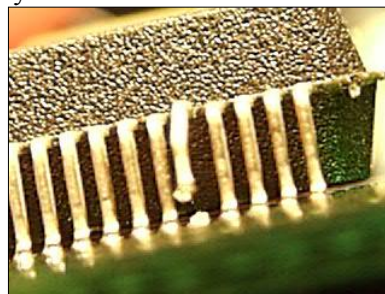
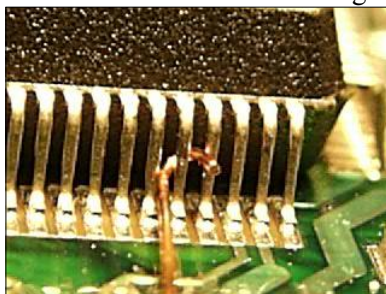

2. Pin 1 of the inverter chip on the inverter module is already lifted, but connected to + polarity (= backlight permanently enabled) the circuit board by a small wire that it can be tested on

arrival of the backlight-kit. In case you **don't** want to switch the backlight by software, please unsolder the wire and carefully move pin 1 back to the solder pad below and solder. The backlight is permanently enabled then.

In case you want the switching by software you can remove the wire or simply unsolder it from the + pad and enlongate it with the CPU-wire later. To improve stability of the "arial" it is recommended to fix pin 1 with a small amount of non-conductive glue at its position.



3. Solder a thin (0.1mm is enough) insulated wire (20cm long) to pin 1 of the inverter chip. This will later be connected to the CPU control pin 48.

Note: Pin 1 of the inverter chip (ELEN, EL enable) can only deal with voltages not higher than $V_{cc} + 0.5V$ (V_{cc} is the voltage of the power supply of the inverter board), i.e. if you plan to connect the inverter chip to another voltage supply other than the +5V supply used here, you must adapt the voltage of the CPU pin, which is a TTL 5V signal. The following describes the process of connecting the inverter chip to +5V, so that you can simply connect the control pin directly to the TTL-signal CPU pin. Example: The inverter chip can in general also deal with $V_{cc}=3V$ or 3.3V. But backlight will be darker then and you would have to lower the CPU pin signal voltage to a maximum of 3.5 or 3.8V for successful software control.

The inverter module

The inverter module converts 5V DC input voltage to about 200V AC output, which is necessary to drive the EL foil. It needs 4 or 5 wires:

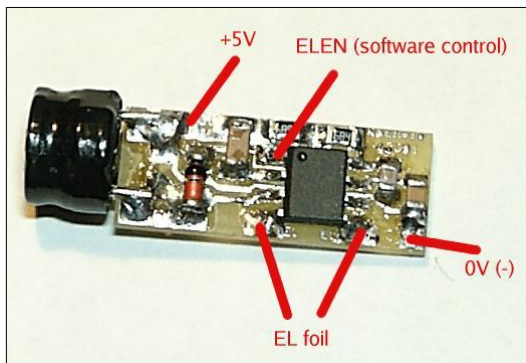

The coil of your inverter may look differently!

- 0V (ground), we will connect this to the large ground contact of the screen
- +5V, this will be taken from the 5V voltage source of the PCMCIA port
- EL foil: these two contacts provide the 200V AC
- ELEN, the software control pin (pin 1 of the IC). Can be connected to +5V (which is the case if you don't lift the pin from the inverter board as described above), then the backlight will be switched on as long as there is an input voltage. Or it can be connected to pin 48 of the CPU, then the backlight is software-driven.

Reassemble the palmtop and connect the backlight

1. Leave the screen in the screen shell, lead the two EL foil wires through the left hinge. It is recommended that you affix them to the ground cable using a piece of heat shrink tubing, and reassemble the screen case: Press the screen halves back together and fasten the four screws.

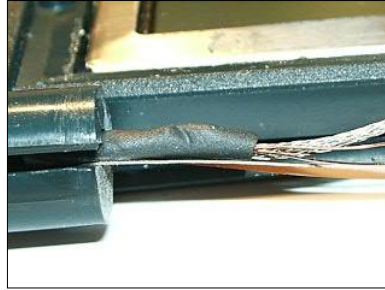
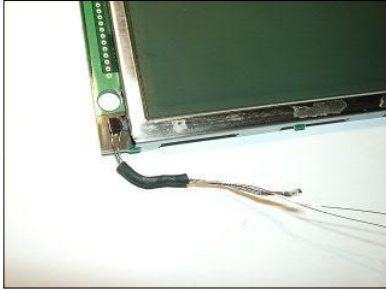

You should repeat the screen testing now, to be sure everything is working properly.

2. Put the ground plate of the screen into its original place in the keyboard shell above the battery compartment.
3. Push the metal pin of the right hinge back into its hole in the keyboard shell
4. Attach wires to the inverter board: One black wire (you can use the one of the battery clip) to 0V, should be about 4cm long. Another wire (red, on these pictures) to +5V, it must be at least 15cm long. And, if you choose software backlight control, a long thin wire (e.g. 0.3mm, 15cm) to the ELEN pin. That's all for now.
5. Solder the black (ground) wire of the inverter to the thick ground cable of the screen.
6. Lead the plus and ELEN wires of the inverter, as the display ribbon cable too, through the hole for the ribbon cable in the keyboard shell. The inverter should now be placed onto the ribbon cable approximately in the middle of the palmtop width.

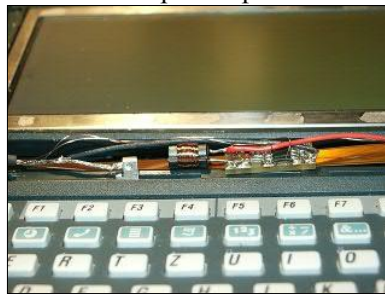

7. Open the two palmtop halves as much as possible and reattach the hinge tube. Press firmly, and take care not to crimp any cables. The inverter with its coil should fit nicely into the tube. If not, rearrange the cables and inverter a bit, so that it fits.

8. Try if the palmtop can be opened and closed without problems. First try very carefully, because crimped cables could be damaged during the movement. Now all you have to deal with in the following are the two cables from the inverter board.

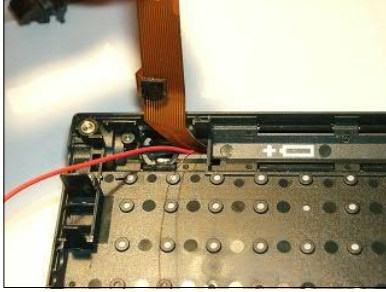

9. Mount the two white disks, with the right one take care about the new wires under it, with the left one take care about the +5V and ELEN cables.

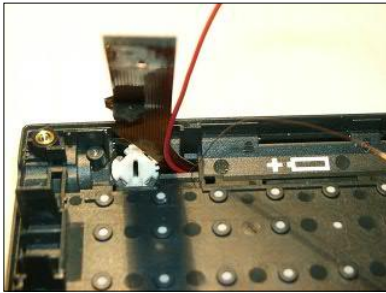

10. Put the motherboard back into its place in the keyboard shell.



11. Cut four pieces of very thin heat shrink tubing (diameter 1mm may be enough), each about 5mm long and put them onto the two wires to combine them to one "cable".

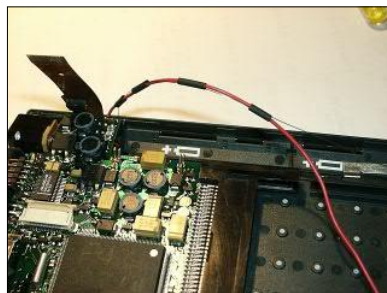

- Lead the combined wires through the valleys of the motherboard as shown in the picture and shrink the heat shrink tubing at convenient positions. The bow on the left is to have some more spare cable in case the motherboard shall be taken out, just for convenience.

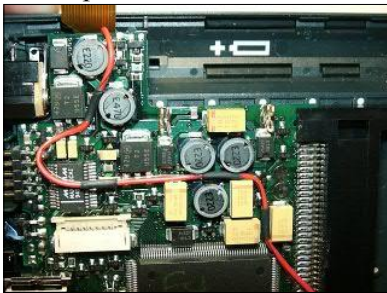

- Connect the screen ribbon cable to its connector on the motherboard.



- Shorten the +5V wire appropriately and solder it to pin 51 of the PCMCIA port.

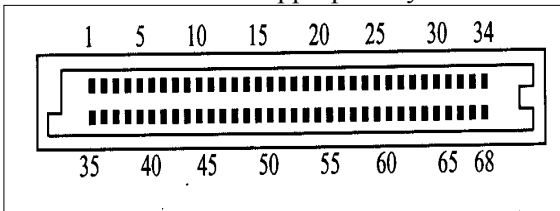

- Then shorten the ELEN wire and solder it to CPU pin 48. Lead the wire over the CPU, so you can fix it with adhesive tape.

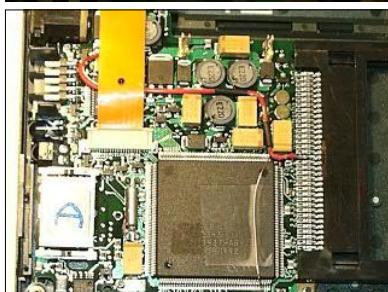
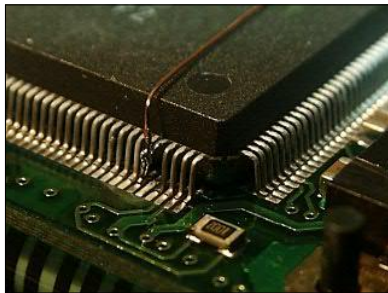
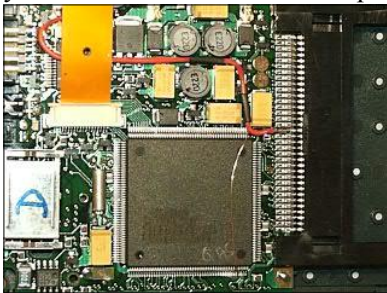

- First test:** Connect the motherboard to an AC adapter, the backlight should now switch on and the usual boot messages should appear on the screen. Disconnect it quickly again, because all the current for the screen and for the backlight now flows only through the ground contact of the screen ribbon cable, since the ground plate of the screen does not yet have a connection to the motherboard ground.

- Put the two body halves back together, press the keyboard contact area together, fasten the four screws and attach the rubber feet.

Load the backlight driver

If you connected the backlight enable wire to pin 48 of the CPU, you can use a software driver to control the backlight using a hotkey. The **backlite.com driver version 2.0 or later** by Stefan Peichl covers all wishes: It has a resident part and a non-resident part. The former one detects the hotkey Fn-X and toggles CPU pin48 high/low, optionally beeps when (de)activating the backlight and it contains a timer, which switches the backlight off after the given amount of time (1..9 minutes). The non-resident part can be used to control the backlight from the command line or a batch file, for example you can use the command `backlite.com /fat` at the beginning of a nightly running backup batch file to make sure the backlight is switched off during the nightly backup.

Download that driver from <http://www.palmtop.net>, search the SUPER archive for "backlite", or use the following URL: <http://www.palmtop.net/cgi-bin/search.pl?Query=backlite>

Install it on your palmtop, for example in `c:\bin`, then add the line `c:\bin\backlite.com /l` to your `autoexec.bat` file. If you call `backlite` from the command line without any parameter, it will show a short help and status screen explaining the switches. After loading `backlite.com` resident, the hotkey Fn-X switches the backlight on and off.

Attention: If you have a double speed upgrade installed, make sure you don't use any Times2Tech speed driver version 2.0 or below! Only the Times2Tech Doublespeed driver (file `SPD31.EXE` or `SPD31.SYS`, usually called from `config.sys`) **version 2.0b** is compatible with the `backlite.com` driver! Download the latest T2T speed driver version here: <http://www.palmtop.net/cgi-bin/search.pl?Query=t2tdrv>.

The older versions of the `backlite` driver on www.palmtop.net are simpler than the recommended version 2.0. They only toggle the control pin high/low (with the hotkey Fn-B, not Fn-X), and one of them inverts the screen automatically everytime the backlight is switched on, this was to support some special optical setups where the screen contents appeared inverted with activated backlight. It is recommended to use version 2.0 or later of the `backlite.com` driver.

